

3 YEARS WARRANTY



DIGITAL SIGNAGE
TOUCHED KIOSK

49" Android OS
49LS2000T

New Media

Bring innovation to life, powered by Android.

Amaze your customers with a smarter, faster, signage display. With integrated WiFi and designed for running Android apps, it's the next evolution in signage solutions.

Product Appearance

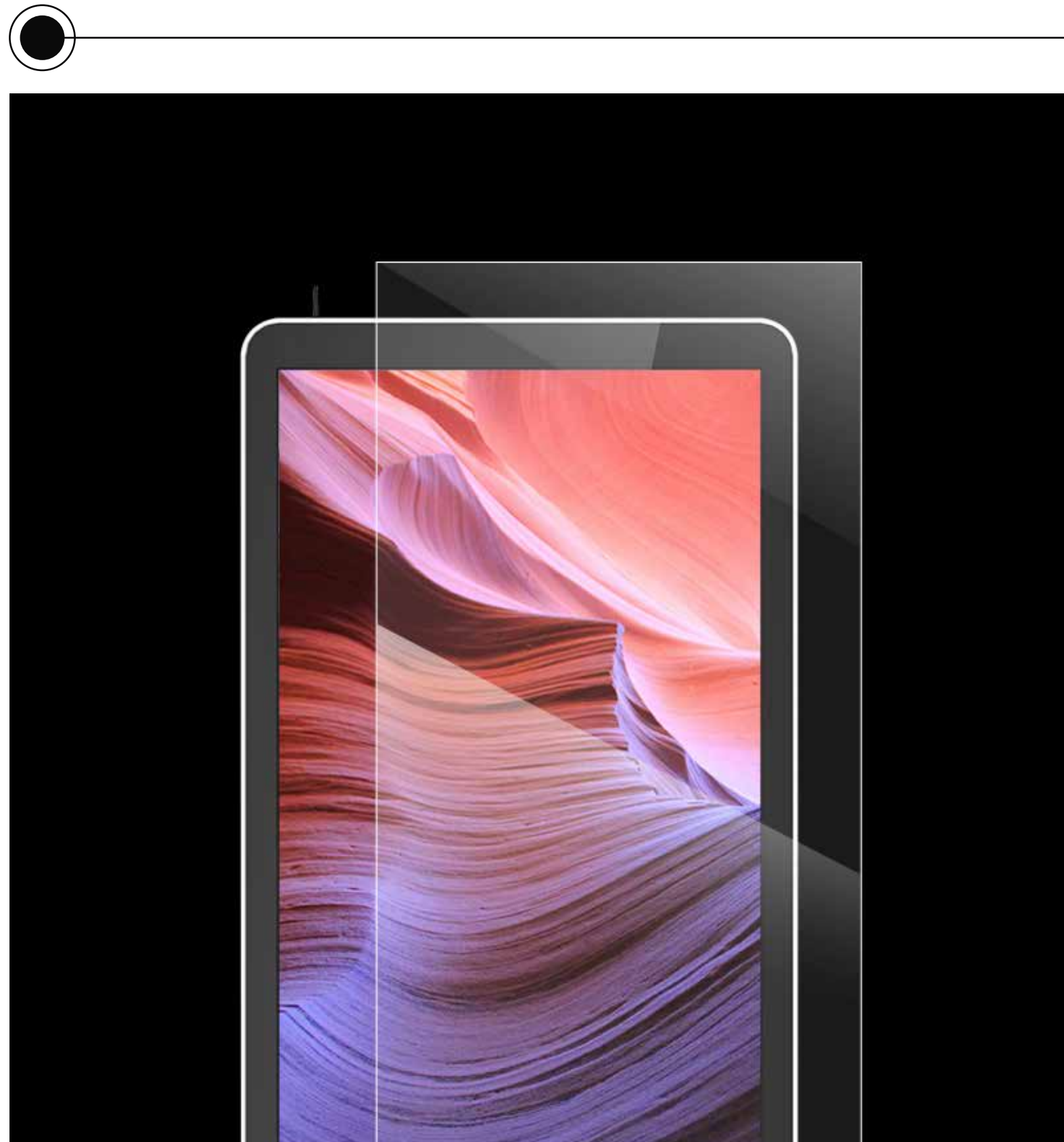

Tempered Glass

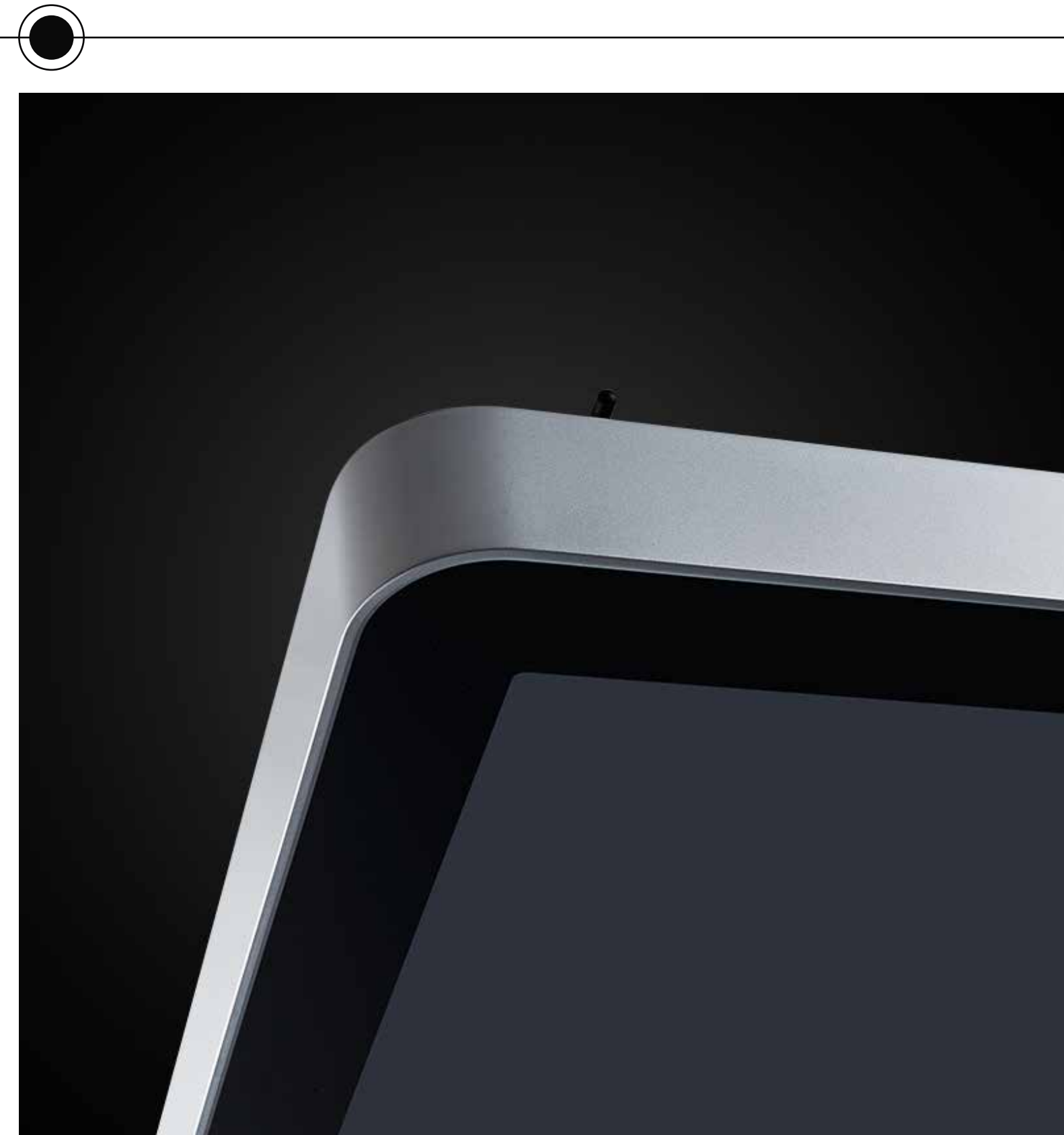

Circular ARC Edge Design

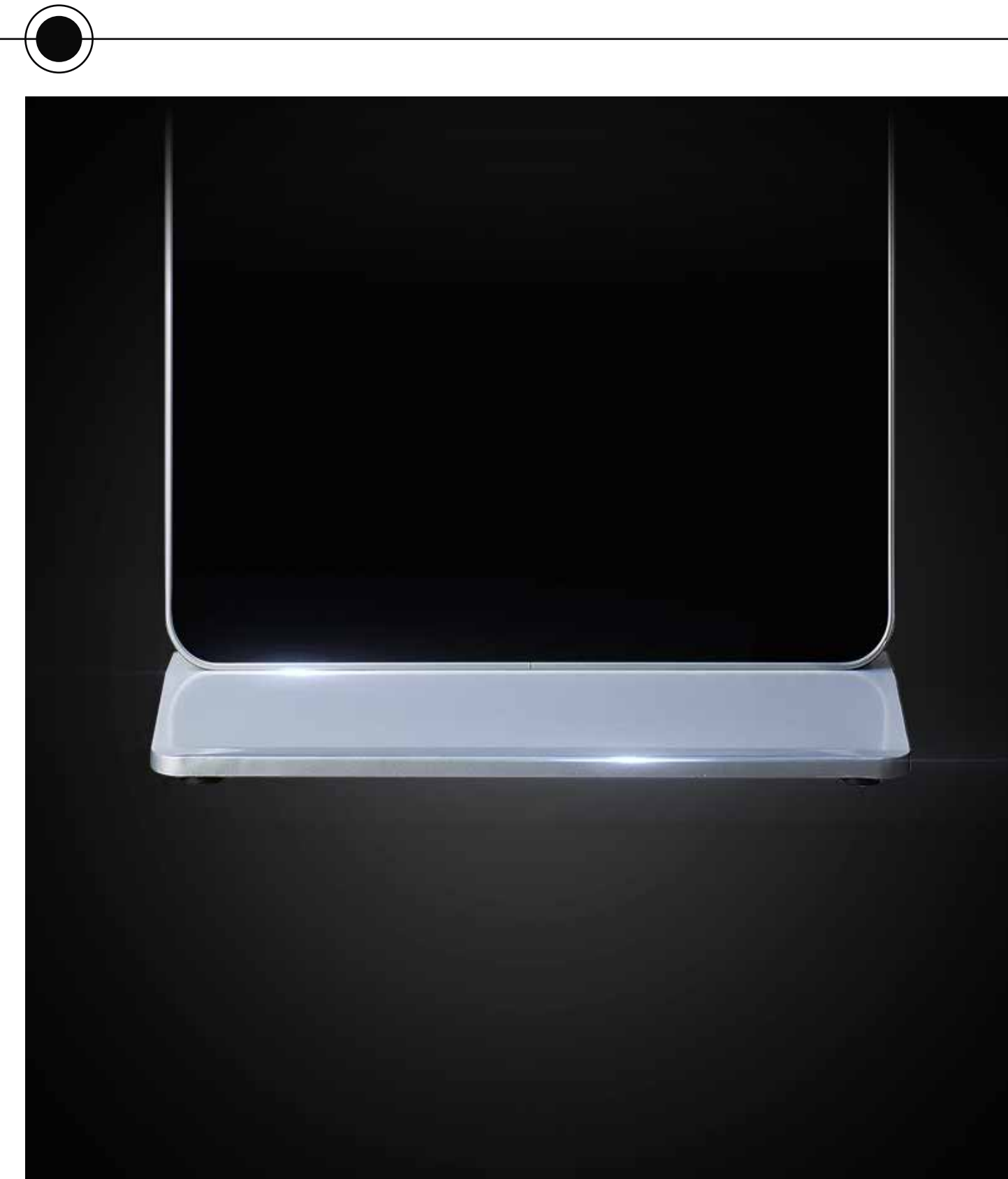

Square Metal Base Design

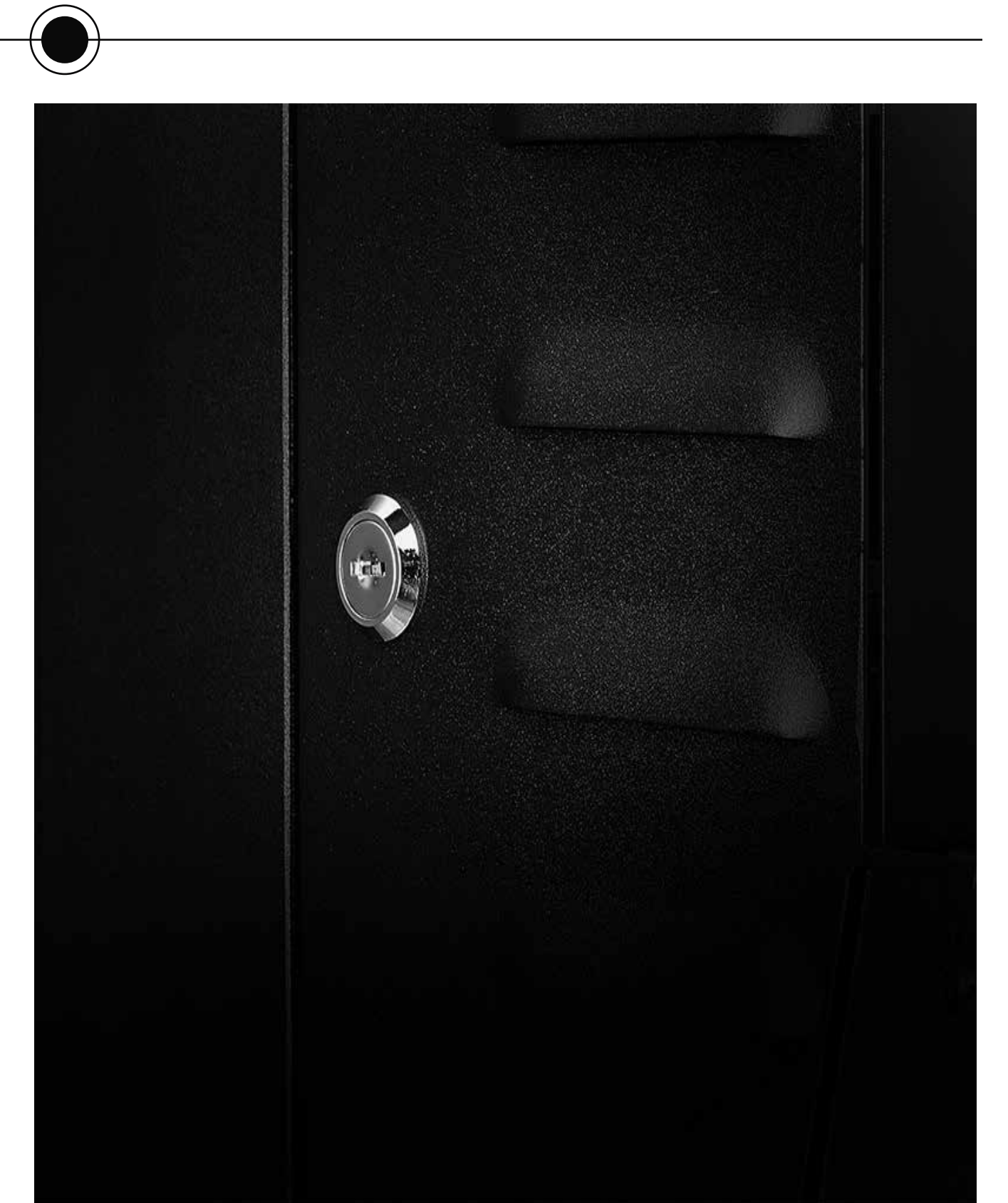

Security Design

CHI Q

1

Full HD Picture Quality



Excellent Display with 1080P Full HD Picture Quality. Create an immersive experience with a LCD panel size of 1920 x 1080 resolution and 16.7M Display Colour.

3

Time Switch & Built for 24/7 Use

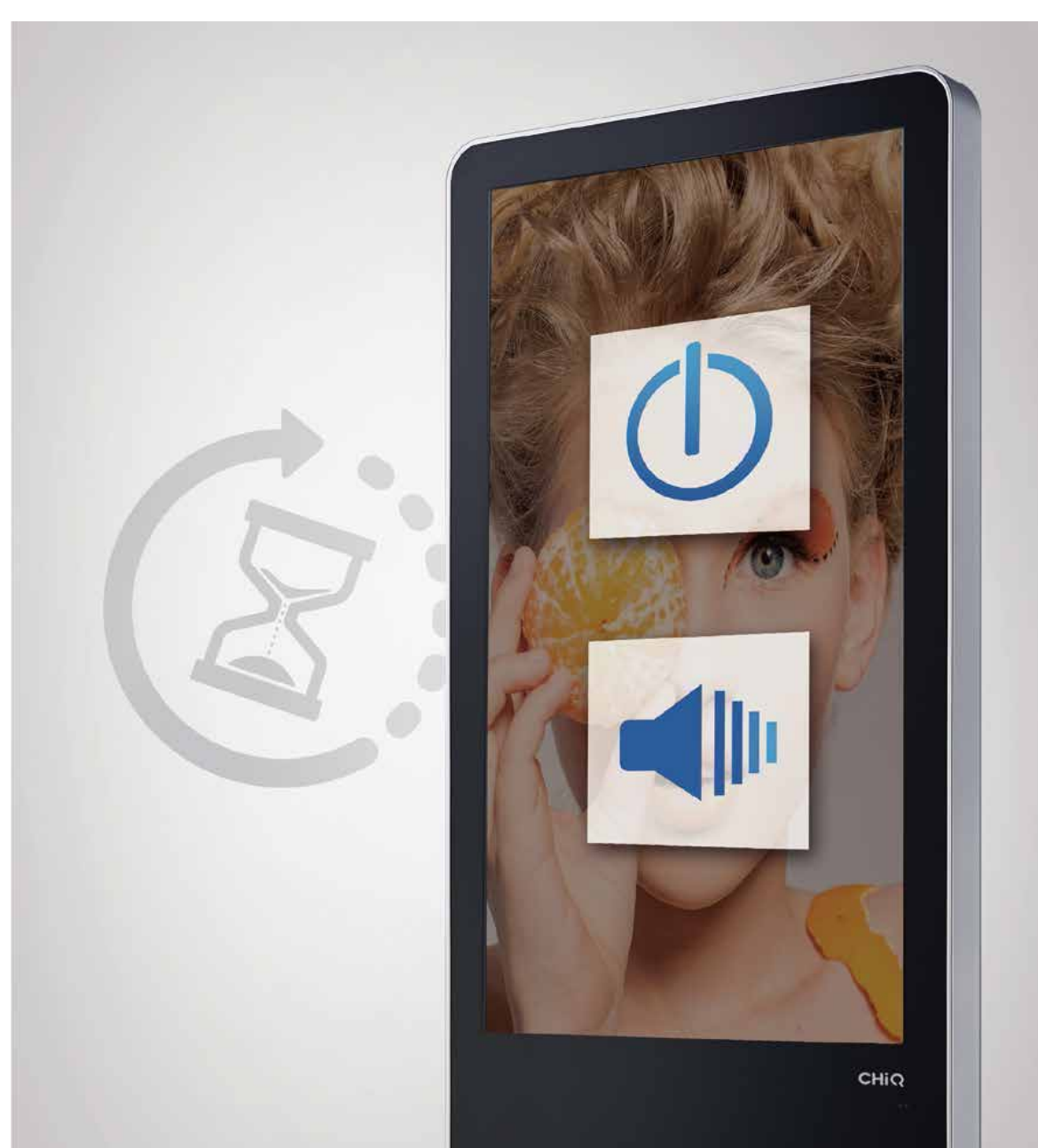

Easily choose the "Week mode" or "Daily mode" and set the switch on & off at any time to control the advertising message. Strong durable support to present your business messaging 24/7.

5

Smart Split Screen

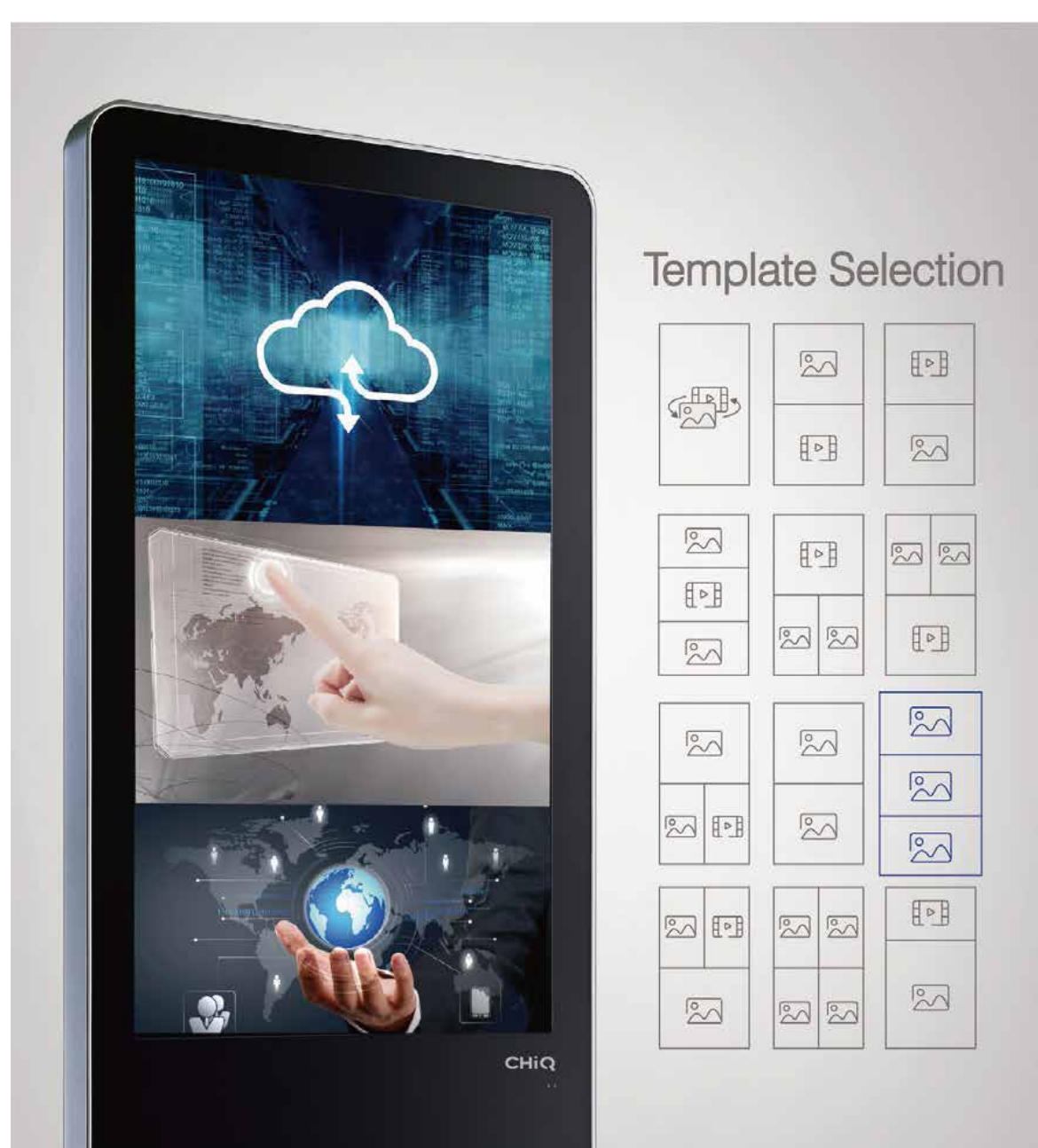

Select Multi-template to easily display Full-Screen picture play, Two\Three\Four Split-screen picture play and Picture & Video mixed arrangement. Simple One-key Split Picture and Video operation. (All play content is copied to the local SProgram folder.)

2

Touch Screen

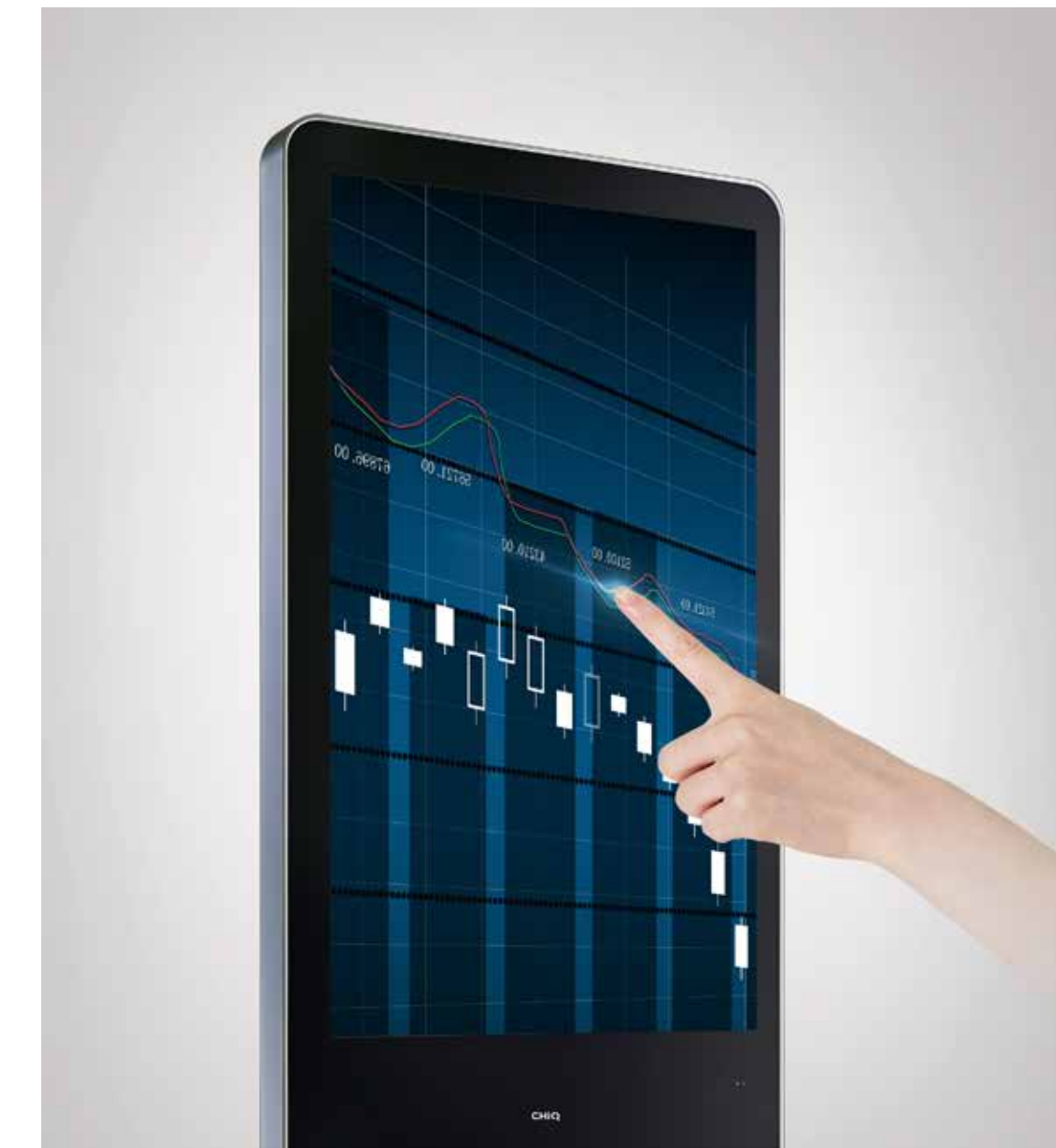

Sensitive touch control makes operation simple and interactive.

4

USB Smart Clone



Create a new folder on the flash disk named SProgram. Put the messaging files (videos, pictures) into the SProgram folder. Plug the flash disk into the USB port on the signage unit and the messaging will be cloned automatically.

[Only takes 50 seconds to clone a 400 Megabyte file.](#)

Display

- Diagonal Screen size: 49 inch
- Panel Resolution: 1920*1080
- Optimum Resolution: 1920*1080@60Hz
- Brightness: 350 cd/m²
- Contrast Ratio (Typical): 1000:1
- Aspect Ratio: 9:16
- Response Time (Typical): 8ms
- Display Colours: 16.7 million
- Viewing Angle (H / V): 178/178 degree

Internal Player

- CPU: Quad Core A17
- GPU: ARM Mali-T764 Quad Core 533 MHz
- Dominant Frequency: 1.8GHz
- Memory: 2 GB DDR3
- Storage: 8 GB EMMC
- Operation System:Android 5.1.1

Connectivity

- USB2.0*1
- Earphone*1
- LAN*1
- TF Cassette *1
- Built-in WiFi

Sound

- Built-in Speakers: 2*5 W RMS

Power

- Standby Power Consumption: <1 W
- Mains Power: 100 ~ 240VAC, 50 ~ 60Hz
- Rated Power Consumption:125W
- MTBF: 30,000 hour(s)

Miscellaneous

- On-Screen Display Languages: English, Simplified Chinese, Traditional Chinese
- Regulatory Approvals: CCC, CB

Multimedia Applications

- USB Playback Audio: AAC, M4A, MP3,WAV, WMA
- USB Playback Picture: BMP, GIF, JPEG
- USB Playback Video: M2TS, M4V, MKV, MP4, MPEG, MPG, MTS, TS, VOB, WMV

Dimensions

- CBU Size(L*H*D): 1850*720*450mm (With Base Stand)
1800*720*91.9mm (Without Base Stand)
- Package Dimension (L*H*D): 1915*205*835mm (Without Base Stand)
735*63*460mm (Base Stand)
- Gross Weight: 64.1Kg (With Base Stand) 56Kg (Without Base Stand)
- Net Weight: 57.8Kg(With Base Stand) 50.4Kg(Without Base Stand)

Accessories

- LED Digital Signage:1 pcs
- User Manual: 1 pcs
- Users Warranty Card: 1 pcs
- Remote Control: 1 pcs
- Base Bracket: 1 pcs
- Battery: 2 pcs

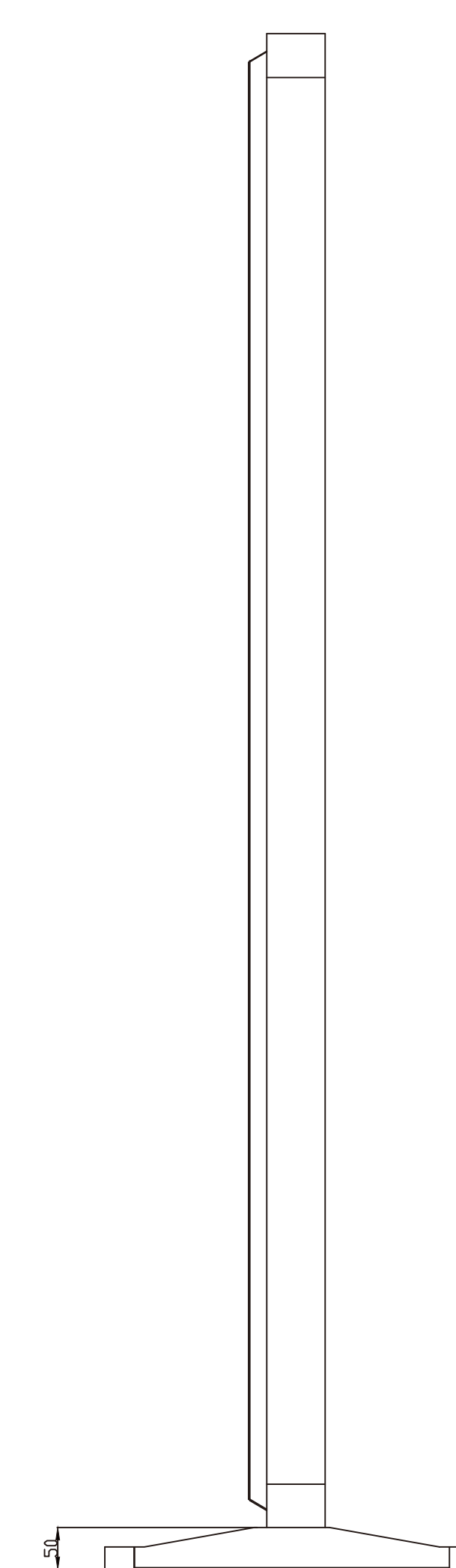
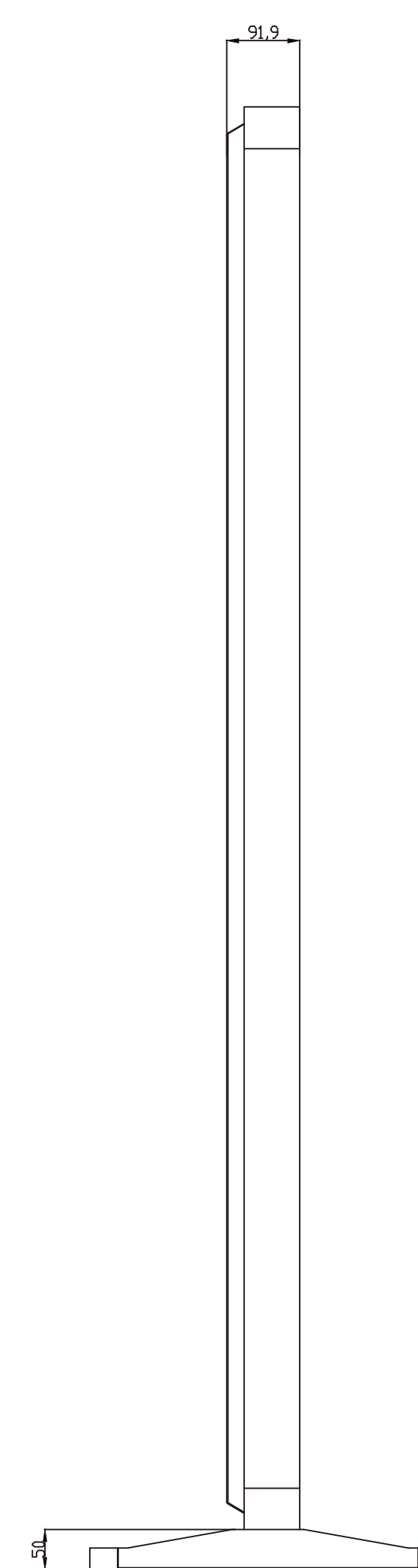
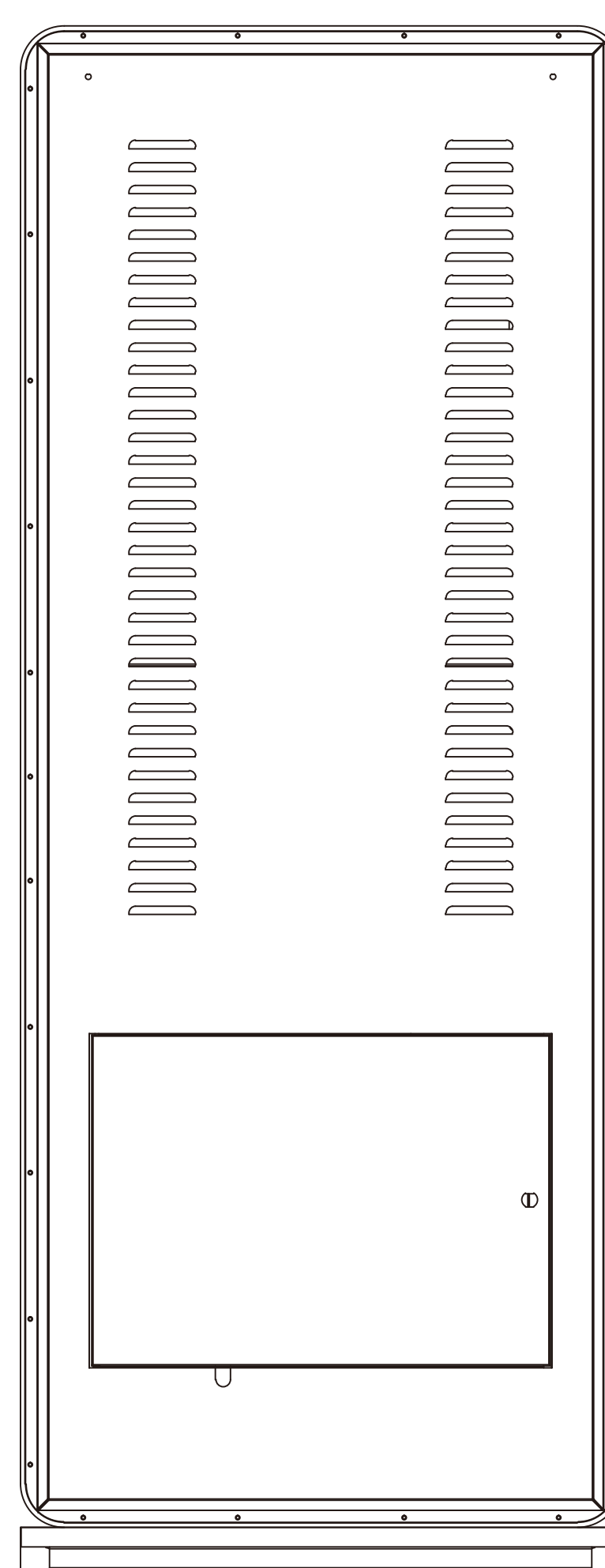
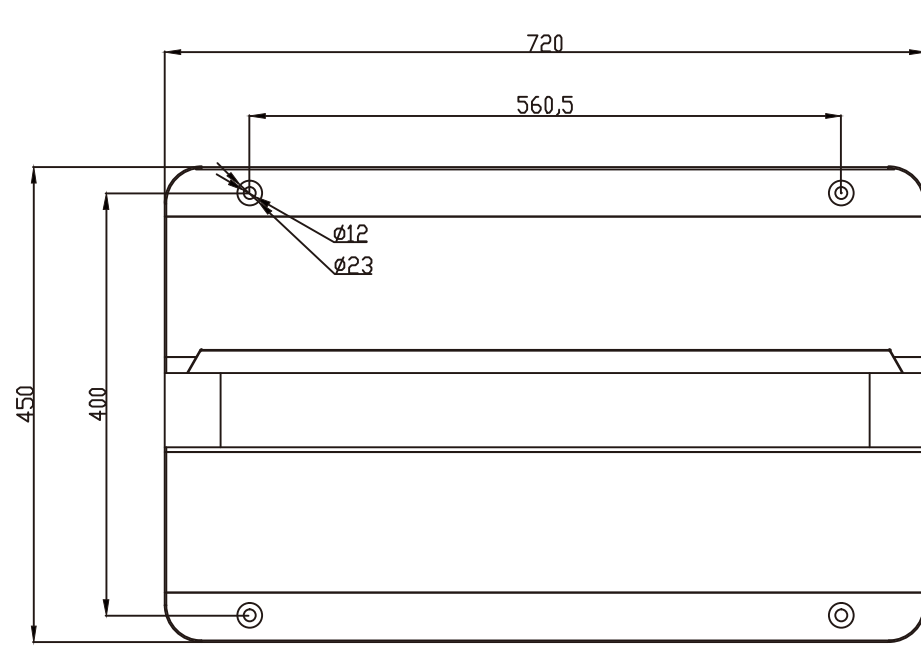
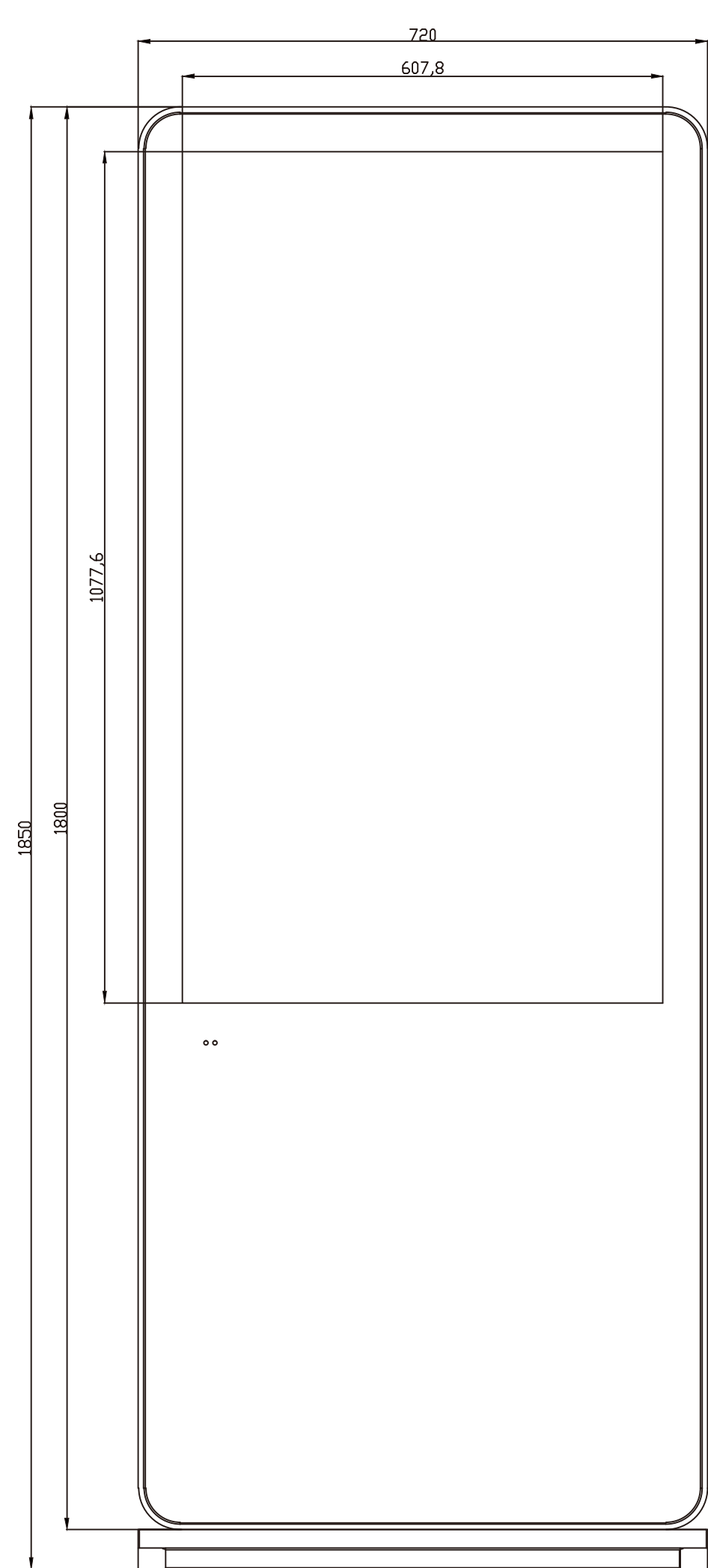

Digital Signage Touch Kiosk

For more information about CHiQ Digital Signage Display ,visit

www.CHiQ.com.au

CHiQ is created by one of China's leading designers and manufacturers of consumer electronics and home appliances, the new generation of CHiQ consumer electronics and electrical home appliances are manufactured by Changhong group.

Copyright©2018 CHANGHONG ELECTRONICS(AUSTRALIA) PTY. LTD.All rights reserved.All brand,product,service names and logos are trademarks and registered trademark of their respective owners and are hereby recognized and acknowledge

CHANGHONG ELECTRONICS(AUSTRALIA) PTY. LTD.

Add: 2/251 ferntree Gully Rd,Mt Waverley,VIC,3149
E-mail:Service@changhong.com.au